

# 5MP ColorHunter HD Fixed Turret Analog Camera

HAC-T325-F28(40)M-W



## Introduction

HAC-T325-F28(40)M-W is a 5MP ColorHunter HD fixed turret analog camera with a high-performance 1/2.7-inch CMOS sensor. It supports TVI/AHD/CVI/CVBS, which effectively enhances product adaptability and diversity of networking solutions. With SYV-75-3 or other coaxial cable types, the camera can achieve low-cost, long-distance, and anti-interference mega-pixel HD video transmission without time delay. The camera supports audio input, synchronous transmission of audio and video, and provides 24/7 color images.

## Features

- 5MP high quality imaging
- TVI/AHD/CVI/CVBS
- Supports white light illumination, 24/7 color images
- Supports 180° horizontal flip, 180° vertical flip
- OSD configuration menu, easy to operate
- IP67 waterproof and dustproof design, high reliability
- OSD configuration menu in 11 languages
- Built-in microphone for high quality audio transmission via coaxial cables
- Metal front face and housing
- 3-Axis

## Specifications

Model	HAC-T325-F28M-W	HAC-T325-F40M-W
<b>Sensor</b>		
Pixel	5MP	
Size	1/2.7"	
Minimum illumination	0.005lux (F1.4, AGC ON) 0 lux (white light on)	
<b>Lens</b>		
Lens	2.8mm	4.0mm
Lens mount	M12	
Angle of view	H: 111.5° V: 58.9° D: 134.8°	H: 89.6° V: 48.3° D: 106.4°
<b>Illuminator</b>		
Illuminator	Two white-light illuminators	
Illumination distance	40m	
Lifetime	≥60,000 hours	
<b>Video</b>		
Resolution	5MP@25fps: 2880(H)×1620(V); 5MP@20fps: 2592(H)×1944(V); 5MP@12.5fps: 2592(H)×1944(V) 4MP: 2560(H)×1440(V) 1080P: 1920(H)×1080(V)	
Frame rate	TVI: 5MP@20fps (default), 5MP@12.5fps, 4MP@30fps, 4MP@25fps, 1080P@30fps, 1080P@25fps AHD: 5MP@20fps, 4MP@30fps, 4MP@25fps, 1080P@30fps, 1080P@25fps CVI: 5MP@25fps, 4MP@30fps, 4MP@25fps, 1080P@30fps, 1080P@25fps CVBS: PAL, NTSC	
Shutter time	PAL: 1/25s-1/50000s NTSC: 1/30s-1/50000s	
<b>Image</b>		
Exposure mode	Four modes: Global (default), BLC, HLC, DWDR	
Day/Night	24/7 color images	
Digital noise reduction	2D	
White balance	Two modes: Auto (default), Manual	
WDR	DWDR	
Flip	Supports 180° horizontal flip, 180° vertical flip	
<b>Audio</b>		
Microphone	Built-in Mic	
Camera audio	TVI: 5MP@20fps, 5MP@12.5fps, 4MP@30fps, 4MP@25fps, 1080P@30fps, 1080P@25fps CVI: 5MP@25fps, 4MP@30fps, 4MP@25fps	
<b>Interface</b>		
Power	5.5mm power interface	
Video output	BNC, supports TVI/AHD/CVI/CVBS	
<b>Operating environment</b>		
Temperature	-30°C to 60°C (-22°F to 140°F)	
Humidity	≤95% (RH, non-condensing)	
Surge protection	4kV	
<b>General</b>		

Power	DC12V (±25%), with reverse polarity protection. Max 3.28W
Mount	Surface mount (default), optional junction box and wall mount bracket
Dimensions	Φ111mm*96mm (diameter*height)
Material	Metal and plastic
Weight	356g (0.79lb)
OSD menu language	11 Languages English, German, Spanish(Latin America), French, Italian, Japanese, Korean, Polish, Portuguese(Brazil), Russian, Turkish
<b>Certification</b>	
EMC	CE-EMC (EN 55032,EN 61000-3-3,EN IEC 61000-3-2,EN 55035) FCC (FCC 47 CFR part15 B)
Safety	CE-LVD (EN 62368-1) CB (IEC 62368-1)
Environment	CE-RoHS (2011/65/EU;(EU)2015/863); WEEE (2012/19/EU)
Protection	IP67 (IEC 60529)

## Dimensions

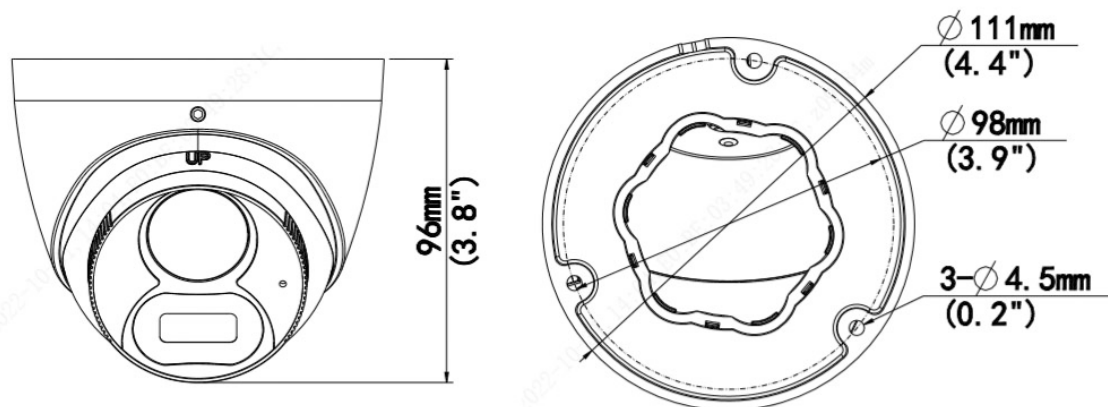

HAC-T325-F28(40)M-W

## Accessories

TR-JB03-G-IN

Junction Box



TR-JB07/WM03-G-IN

Wall Mount

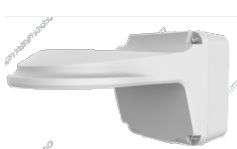

TR-WM03-D-IN

Wall Mount

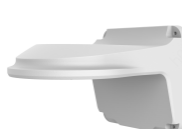

TR-A01-IN

Waterproof Joint



TR-UP06-IN

Pole Mount



TR-UC08-C

Corner Mount

TR-SE24-IN

Pendant Mount

TR-SE24-A-IN

Pendant Mount

TR-CM24-IN

Pendant Mount

PWR-DC1201A-IND

Wall Plug-in IND  
Power Adapter

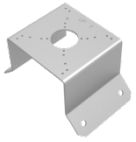

PWR-DC1201A-UK,  
PWR-DC1201B-UK

Wall Plug-in UK  
Power Adapter

PWR-DC1201A-US,  
PWR-DC1201B-US

Wall Plug-in US  
Power Adapter

PWR-DC1201A-EU,  
PWR-DC1201B-EU

Wall Plug-in EU  
Power Adapter



Mount

TR-JB03-G-IN

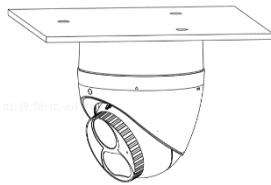

TR-JB07/WM03-G-IN(TR-WM03-D-IN)

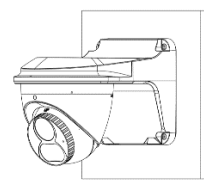

TR-JB07/WM03-G-IN(TR-WM03-D-IN)+TR-UP06-IN

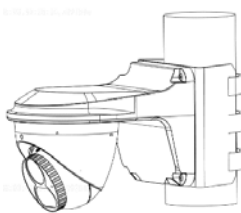

TR-JB07/WM03-G-IN(TR-WM03-D-IN)+TR-UC08-C

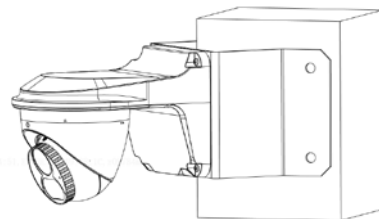

TR-CM24-IN+TR-JB03-G-IN

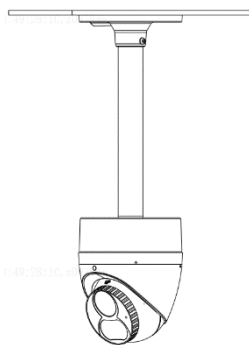

**Zhejiang Uniview Technologies Co., Ltd.**

Building No. 369, Xietong Road, Xixing Sub-district, Binjiang District, Hangzhou City, Zhejiang Province, China (310051)

Email: [overseasbusiness@uniview.com](mailto:overseasbusiness@uniview.com); [globalsupport@uniview.com](mailto:globalsupport@uniview.com)

<https://www.uniview.com>

©2023 Zhejiang Uniview Technologies Co., Ltd. All rights reserved.

\*Product specifications and availability are subject to change without notice.